



LG

Visit us at : <http://www.lgservice.com>

LG

LG

Dry contact for communication

Owner's & installation manual

Models: PQDSBC

IMPORTANT

- Please read this manual completely before installing the product.
- Installation work must be performed in accordance with the national wiring standards by authorized personnel only.
- Please retain this installation manual for future reference after reading it thoroughly.

TABLE OF CONTENTS

■ Safety Precautions	3~4
■ Name of each part	5
■ Installation Method	6~7
Installation inside of the indoor unit.....	6
Installation outside of the indoor unit	7
■ Setting and using method	8~18
1. Power supply and indoor unit connection.....	8
2. Setting of Contact Signal Input	9
3. Setting the desired temperature	10
4. Control mode setting	11
5. Indoor unit monitoring	15

Safety Precautions



To prevent injury to the user or other people and property damage, the following instructions must be followed.

- Incorrect operation due to ignoring instruction will cause harm or damage. The seriousness is classified by the following indications.

⚠ WARNING This symbol indicates the possibility of death or serious injury.

⚠ CAUTION This symbol indicates the possibility of injury or damage.

- Meanings of symbols used in this manual are as shown below.

	Be sure not to do.
	Be sure to follow the instruction.

⚠ WARNING

■ During installation

Do not touch the board when the power is connected.

- It can cause a fire, electric shock, explosion, injury and problem to the product.

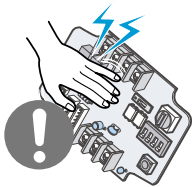

Always request for installation of the product to the service center or the installation service provider.

- It can cause a fire, electric shock, explosion and injury.

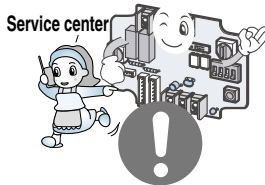

When reinstalling the previously installed product, request for service to the service center or the installation service provider.

- It can cause a fire, electric shock, explosion and injury.



Do not install the product where it can be exposed to rain.

- It can cause problems to the product.

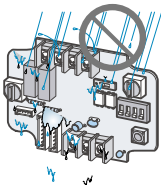

Do not install the product in a humid location.

- It can cause problems to the product.

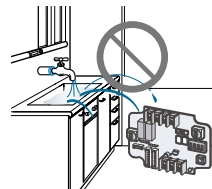

■ During use

Do not modify or extend the power cord.

- It can cause a fire and electric shock.

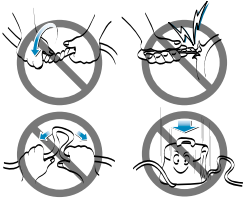

Do not use any flaming devices near the product.

- It can cause a fire.

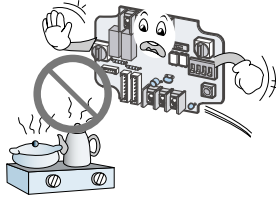

Do not use any heating devices near the power cord.

- It can cause a fire and electric shock.

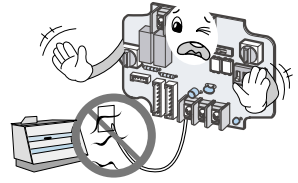

Do not pour water inside the product.

- It can cause an electric shock and problem to the product.

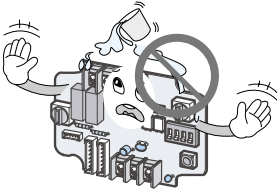

When the product is submersed in water, always request for service to the service center or the installation service provider.

- It can cause a fire and electric shock.

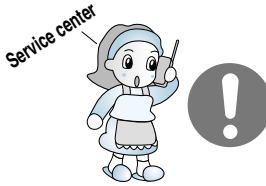

Make the children and the elderly use the product with the help of a guardian.

- It can cause a safety accident and problems to the product.

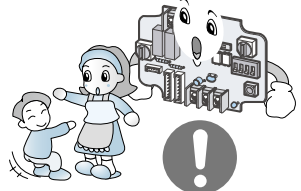

Do not give impact to the product.

- It can cause problems to the product.

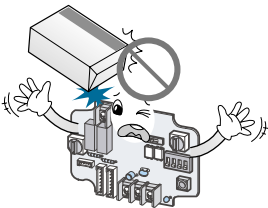

Name of each part

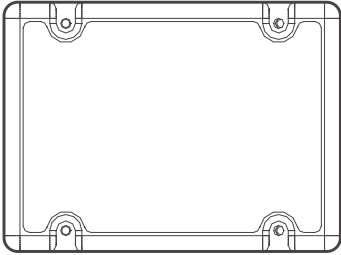

(Front case)

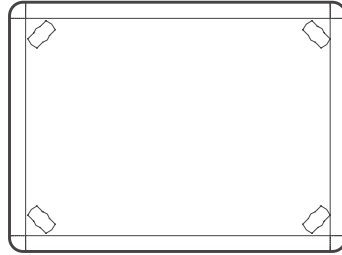

(Rear case)

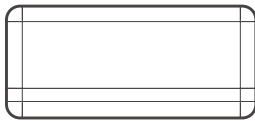

(Top)

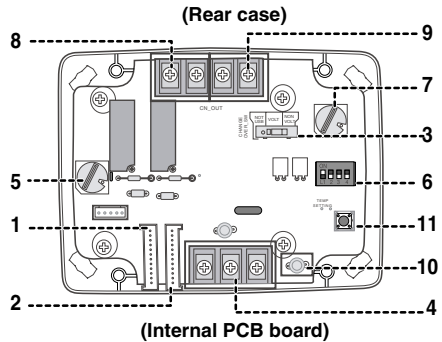

(Internal PCB board)

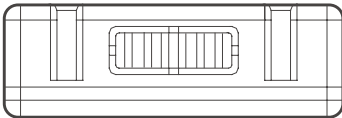

(Side)

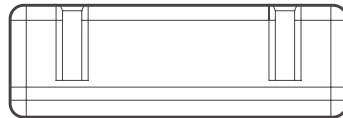

(Side)

DRY CONTACT FOR COMMUNICATION (DRY_CONTACT FOR COMMUNICATION)

1. **CN_INDOOR** : Connect communication wire between indoor unit and Dry contact for communication and supply power to Dry contact for communication
2. **CN_PI485** : PI485 connector
3. **CHANGE_OVER_SW** : Switch to select voltage (5V-12V) of contact point
4. **CN_CONTROL** : Contact point signal input
5. **CONTROL_MODE_SW** : Switch to select the control mode
6. **SETTING_SW** : Switch to select whether to use set function of Dry contact for communication
7. **TEMP_SETTING** : Switch to set the desired temperature of the indoor unit
8. **CN_OUT (O1, O2)** : Connector to show whether the indoor unit is operating
9. **CN_OUT (E3, E4)** : Connector to show whether there is an error with the indoor unit
10. **DISPLAY_LED** : LED to display the status of the Dry contact for communication
11. **RESET_SW** : Reset switch

Installation Method

Installation inside of the indoor unit

- ① Loose 4 screws anchoring PCB and then separate the rear case and PCB

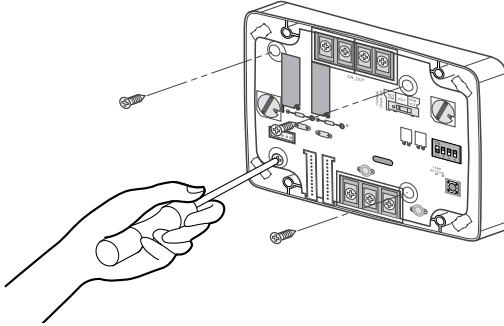

- ② Connect the connection wires according to the instructions. (Please refer to Setting and Using Method)
- ③ Perform the switch setting according to switch setting method. (Please refer to Setting and Using Method)
- ④ Fix PCB on suitable space inside of the indoor unit.

▲ CAUTION

1. Install the product on flat surface and install anchoring screws at more than 2 places. Otherwise the central controller may not be anchored properly.
2. Do not tighten anchoring screws too tightly. It may cause deformation of the case.
3. Do not deform the case at random. It may cause malfunction of the central controller.

Installation outside of the indoor unit

- ① Anchor the rear case of Dry Contact for communication on the installation surface at holes using anchor screws.

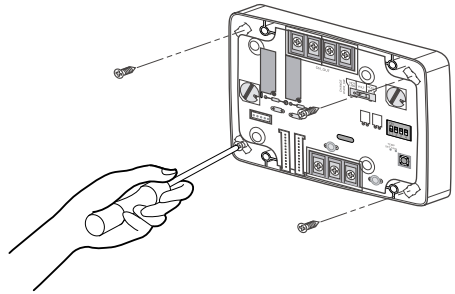

- ② Please cut the pole which is located in side of the front case properly.

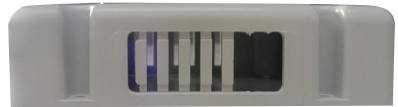
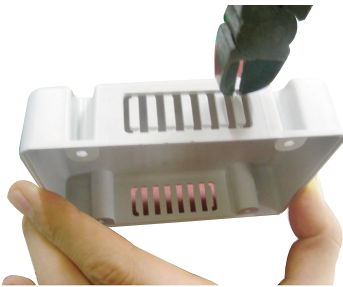

- ③ Connect connection wires according to the instructions.
(Reference to Setting and Using Method)
Then, connect wire to PCB after going through hole of ②.

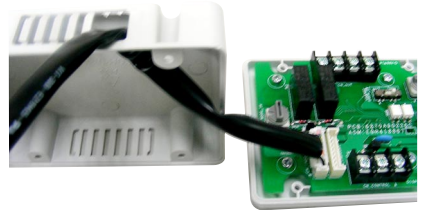

- ④ Perform the switch setting according to switch setting method. (Reference to Setting and Using Method)
⑤ Join the front case and the rear case, anchor the front case at holes using anchor screws.

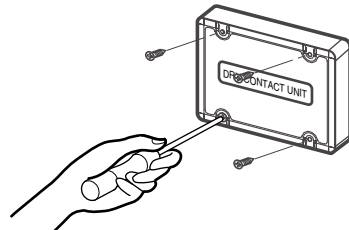

⚠ CAUTION

1. Install the product on flat surface and install anchoring screws at more than 2 places. Otherwise the central controller may not be anchored properly.
2. Do not tighten anchoring screws too tightly. It may cause deformation of the case.
3. Do not deform the case at random. It may cause malfunction of the central controller.

2. Setting of Contact Signal Input

■ For no power contact point signal input

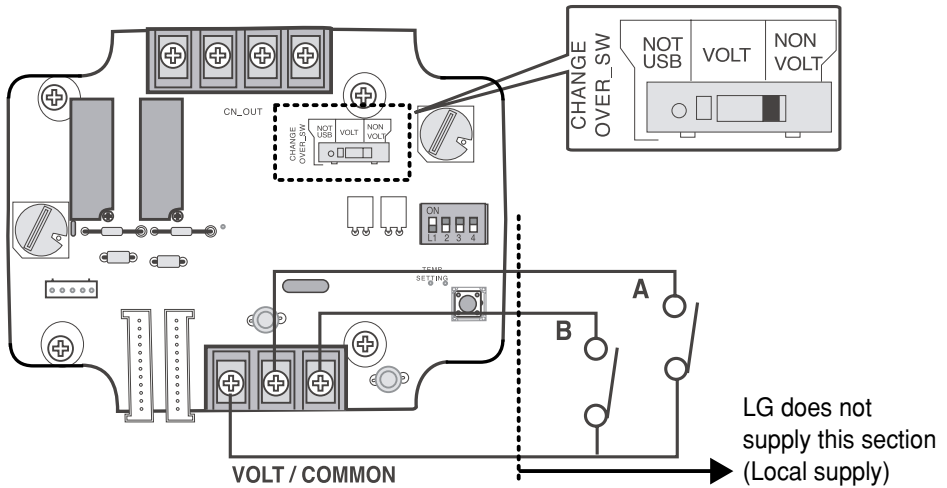

■ For power contact point signal input

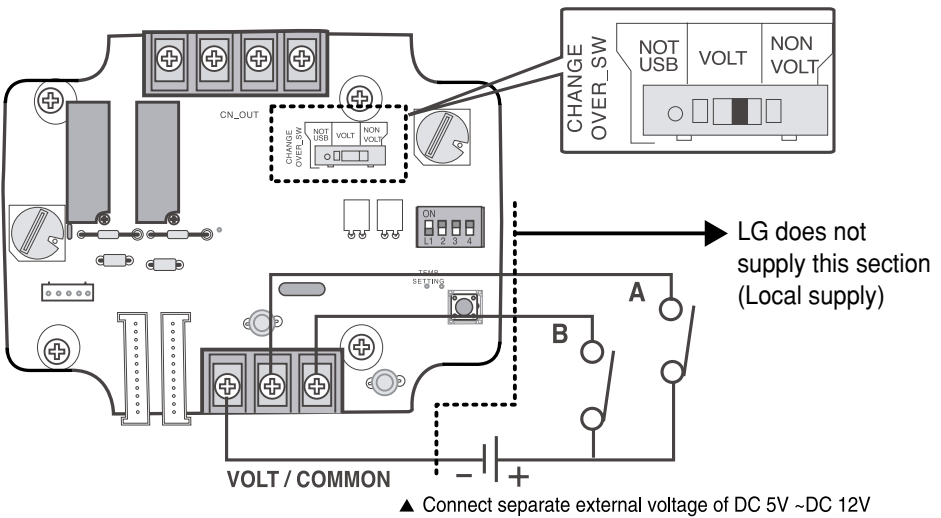

3. Setting the desired temperature

■ When setting the desired temperature of the Dry contact for communication

: When operating the indoor unit, set the desired temperature according to the TEMP_SW setting. When the indoor unit is unlocked, the desired temperature can be reset by other controller

1) Turn on the TEMP_SETTING switch of SETTING_SW.

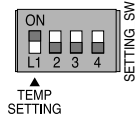

2) Use the TEMP_SW to set the temperature as shown below.

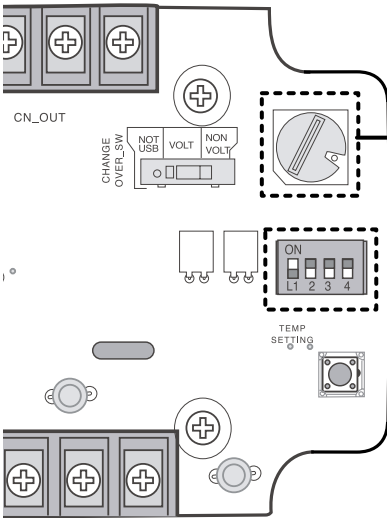

Desired temperature setting table

TEMP SW setting	0	1	2	3	4	5	6	7
Temperature setting(°C)	18	19	20	21	22	23	24	25
TEMP SW setting	8	9	A	B	C	D	E	F
Temperature setting(°C)	26	27	28	29	30	30	30	30

■ When not using the desired temperature setting of Dry contact for communication

1) Turn off the TEMP_SETTING switch of SETTING_SW.

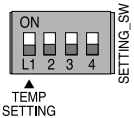

⤷ When operating the indoor unit initially in Dry contact for communication, set the desired temperature to 18°C.

4. Control mode setting

- Use the CONTROL_MODE_SW to set the control mode you want from 0~D.

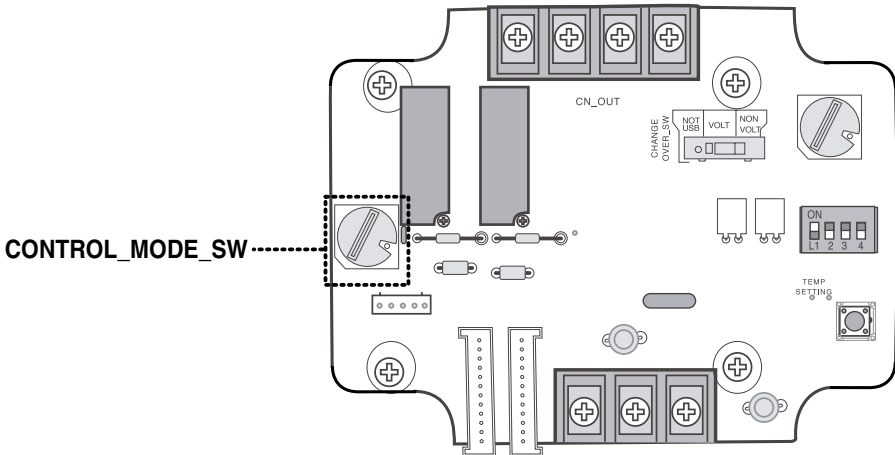

▷ Indoor control priority

Central control > Dry contact for communication > Wired/Wireless remote controller, indoor unit button

- ▷ Dry contact for communication controls the indoor unit according to the applicable mode when there is a change in input of A and B.

■ Description of each control mode

1) Cancel mode for use of dry contact for communication

CONTROL_MODE S/W	Input A	Input B	Operating mode
0	OFF	OFF	The indoor unit cannot be controlled through the Dry contact for communication No change in indoor unit condition
	ON	OFF	
	OFF	ON	
	ON	ON	

- ▷ Set this when the Dry contact for communication is connected but not used.

2) General mode

CONTROL_ MODE S/W	Input A	Input B	Operating mode
1	OFF	OFF	Indoor unit stopped, locked
	ON	OFF	Indoor unit prior operating condition maintained, unlocked
	OFF	ON	Indoor unit stopped, locked
	ON	ON	Indoor unit stopped, locked
2	OFF	OFF	Indoor unit stopped, locked
	ON	OFF	Indoor unit operating, unlocked
	OFF	ON	Indoor unit stopped, locked
	ON	ON	Indoor unit stopped, locked
3	OFF	OFF	Indoor unit stopped, locked
	ON	OFF	Indoor unit stopped, locked
	OFF	ON	Indoor unit prior operating condition maintained, unlocked
	ON	ON	Indoor unit operating, unlocked
4	OFF	OFF	Indoor unit stopped, locked
	ON	OFF	Indoor unit stopped, locked
	OFF	ON	Indoor unit prior operating condition maintained, unlocked
	ON	ON	Indoor unit prior operating condition maintained, unlocked
5	OFF	OFF	Indoor unit prior operating condition maintained, locked
	ON	OFF	Indoor unit prior operating condition maintained, locked
	OFF	ON	Indoor unit prior operating condition maintained, locked
	ON	ON	Indoor unit prior operating condition maintained, unlocked
6	OFF	OFF	Indoor unit prior operating condition maintained, locked
	ON	OFF	Indoor unit prior operating condition maintained, locked
	OFF	ON	Indoor unit prior operating condition maintained, locked
	ON	ON	Indoor unit operating, unlocked

3) Fan level setting mode

CONTROL_ MODE S/W	Input A	Input B	Operating mode
7	OFF	OFF	Indoor unit operating at low level, locked
	ON	OFF	Indoor unit operating at low level, unlocked
	OFF	ON	Indoor unit stopped, locked
	ON	ON	Indoor unit stopped, locked
8	OFF	OFF	Indoor unit operating at low level, locked
	ON	OFF	Indoor unit operating at low level, unlocked
	OFF	ON	Indoor unit stopped, locked
	ON	ON	Indoor unit prior operating condition maintained, unlocked

○ When the indoor unit is operating in Dry contact for communication, the fan level can be changed by other controller when the fan level is set to low level and the indoor is in unlocked condition.

4) Power save mode

CONTROL_ MODE S/W	Input A	Input B	Operating mode
9	OFF	OFF	Indoor unit operating in power save mode, locked
	ON	OFF	Indoor unit operating in power save mode, unlocked
	OFF	ON	Indoor unit stopped, locked
	ON	ON	Indoor unit operating not in power save mode, unlocked
A	OFF	OFF	Indoor unit operating in power save mode, locked
	ON	OFF	Indoor unit operating in power save mode, unlocked
	OFF	ON	Indoor unit stopped, locked
	ON	ON	Indoor unit stopped, locked

○ When setting 9, A mode, the TEMP_SETTING must always be set to ON.

○ Power save mode: Adjust the set temperature to +3°C for cooling and -3°C for heating.

5) Compressor stop mode

CONTROL_ MODE S/W	Input A	Input B	Operating mode
B	OFF	OFF	Indoor unit operating (Compressor in stop mode), locked
	ON	OFF	Indoor unit prior operating condition maintained (Compressor not in stop mode), unlocked
	OFF	ON	Indoor unit stopped, locked
	ON	ON	Indoor unit stopped, locked

▷ Compressor stop mode: The compressor is stopped during cool/heat operation.

6) Operating mode selection mode

CONTROL_ MODE S/W	Input A	Input B	Operating mode
C	OFF	OFF	Indoor unit stopped, unlocked
	ON	OFF	Indoor unit in cool/high operation, unlocked
	OFF	ON	Indoor unit in heat/high operation, unlocked
	ON	ON	Indoor unit in fan/high operation, unlocked
D	OFF	OFF	Indoor unit stopped, locked
	ON	OFF	Indoor unit in cool/high operation, locked
	OFF	ON	Indoor unit in heat/high operation, locked
	ON	ON	Indoor unit in fan/high operation, locked

▷ Power save mode: Adjust the set temperature to +3°C for cooling and -3°C for heating.

5. Indoor unit monitoring

- **Monitoring whether the indoor unit is operating: Refer to below and connect to the control device that you want to control.**

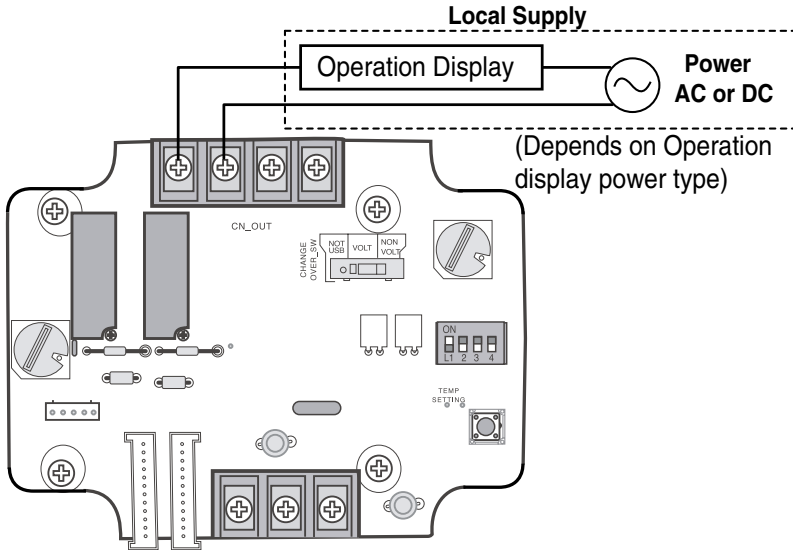

- **Monitoring indoor unit error: Refer to below and connect to the control device that you want to control.**

